



# Immersive HD Model 10HDR-AW-70V



## Description:

The 10HDR-AW-70V is an all-weather high definition compact subwoofer, featuring a high power 10" long throw all weather low frequency transducer.

High-performance custom built 70 volt 300 watt toroid transformer with low insertion loss and linear response for use when long wire runs or distributed audio is a requirement. The ported composite enclosure as well as all components are designed to withstand the harshest of environmental conditions in any permanent outdoor installation.

The Model 10HDR-AW-70V Subwoofer delivers the punch, impact and clean tight bass necessary for outdoor installations. The perfect compliment to our Immersive HD Loudspeakers, delivering the ultimate in "High Definition" audio for any outdoor environment. Backyard landscapes, patio and pool areas will come alive with unparalleled clarity and detailed sound, engineered to give you years of listening satisfaction and pleasure.

## Features:

- All weather long throw woofer featuring a super stiff composite cone, large rubber surround, massive motor structure in a tuned, down firing enclosure
- All weather robust enclosure IP-26 per IEC529
- Cylindrical design reduces standing waves
- Included rubber feet for vibration and skid free operation on hard surfaces
- All stainless-steel hardware
- 70 volt 300 watt custom toroid transformer for use when long wire runs / distributed audio is a requirement



70 volt 300 watt custom toroid transformer,

## Applications:

- For any permanent outdoor installation
- Backyard landscapes, patio and pool areas
- Houses of Worship
- Performing Arts Theaters
- Athletic Facilities
- Convention Centers
- Theme Parks
- Museums
- Airports & Train Stations
- Challenging Acoustic Spaces
- Multi-Purpose Venues
- Audio, Video Production

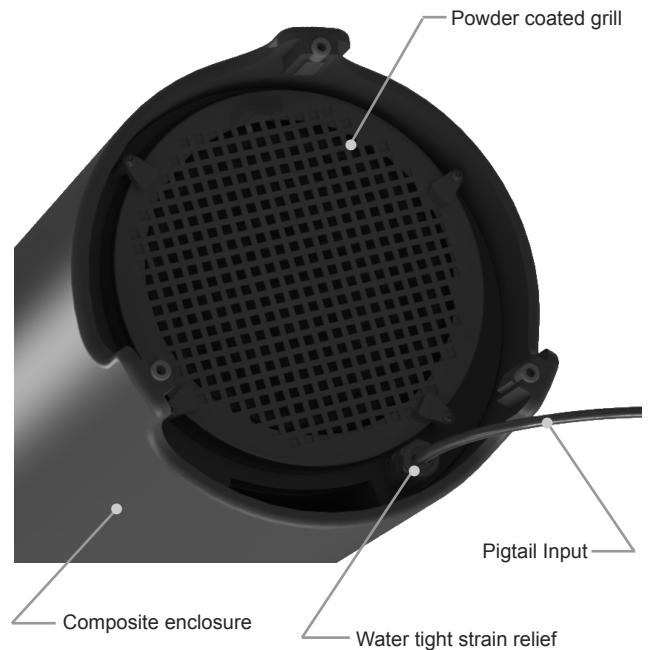

# 10HDR-AW-70V Specifications

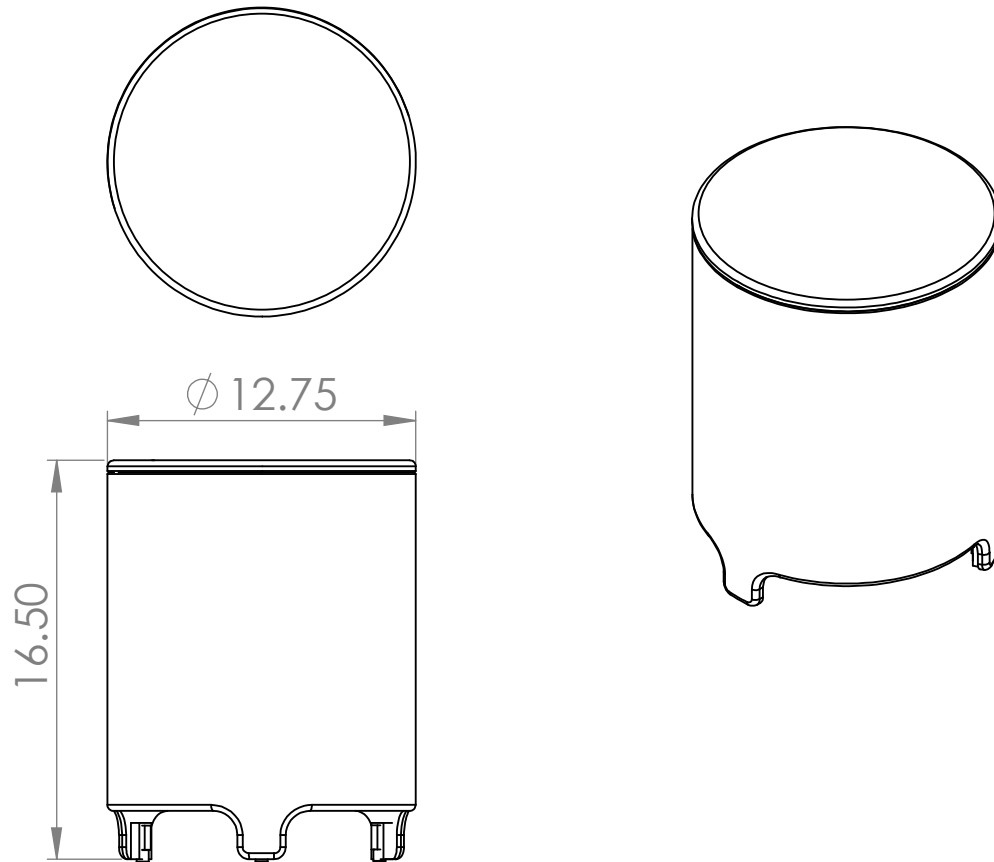

System Type	Vented alignment subwoofer
Driver Components	All-weather 10" long throw woofer
Crossover	Recommended HPF=37hz 12db per octave Butterworth
Frequency Response	35hz - 300Hz (-10db) 50hz – 300hz +/- 3db
Maximum SPL	118db Continuous, 124db Peak
Sensitivity, 1m/2.83V	93 dB
Power Handling	300W AES, 600W Program, 1200W Peak
Recommended Amplifier Power	300 watts minimum
Transformer	70 volt 300 watt
Input Connectors	24" x 12awg pigtail with water proof wire nuts
Enclosure	Ported composite
Dimensions, (H x W) inches (mm)	16.5" (41.9cm) x 12.75" (32.4cm)
Weight, net / shipping	35Lbs (15.4kg) / 39Lbs (17.6kg)
Warranty	Limited 3-year warranty

